

MULTISPAN

User Manual

APFC 116



Multispan Control Instruments Pvt Ltd

72/B, Phase 1, GIDC Estate, Vatva, Ahmedabad-382445, Gujarat, India.

✉ service@multispanindia.com ☎ +91-9978991482

🌐 www.multispanindia.com

Technical Specification

INPUT:

Voltage AC	
Input voltage AC	300 to 520V AC (L - L)
Burden	< 8 VA
Frequency	50/60 Hz
Current AC(1 CT Sensing)	
Primary CT Ratio	5 to 9999 Amp Selectable
Secondary Current Ac	10mA To 5 Amp (Without CT)
Burden	< 0.8 VA
Overload	Up to 6A Continuous

DISPLAY, KEY & LED:

Display	Upper: 4 Digit, 7 seg, 0.60" Lower: 7 Digit, 7 seg, 0.38"
Key	SET/ENT, INC, DEC, EXIT

DIMENSION:

Size	144 (H) x 144 (W) x 80 (D) mm
Panel Cutout	138 (H) x 138 (W) mm

CONTROLLING RANGE:

Operating Mode	Kvar / Intel / Manual
Programmable Hysteresis	0 to 25 KVAR

OUTPUT SPECIFICATION:

16 Stage Capacitor Relay	
Relay Type	(NO-C)
Rating	7A, 250V AC

AUXILIARY SUPPLY:

Supply voltage	300V to 520V AC (L-L)
Power consumption (VA RATING)	Approximately 10VA

ACCURACY:

Class 0.5 (Standard)

ENVIRONMENT CONDITION:

Operating Temp.	0 °C to 55 °C
Relative Humidity	UP to 95% RH (non-condensing)

Terminal Connection

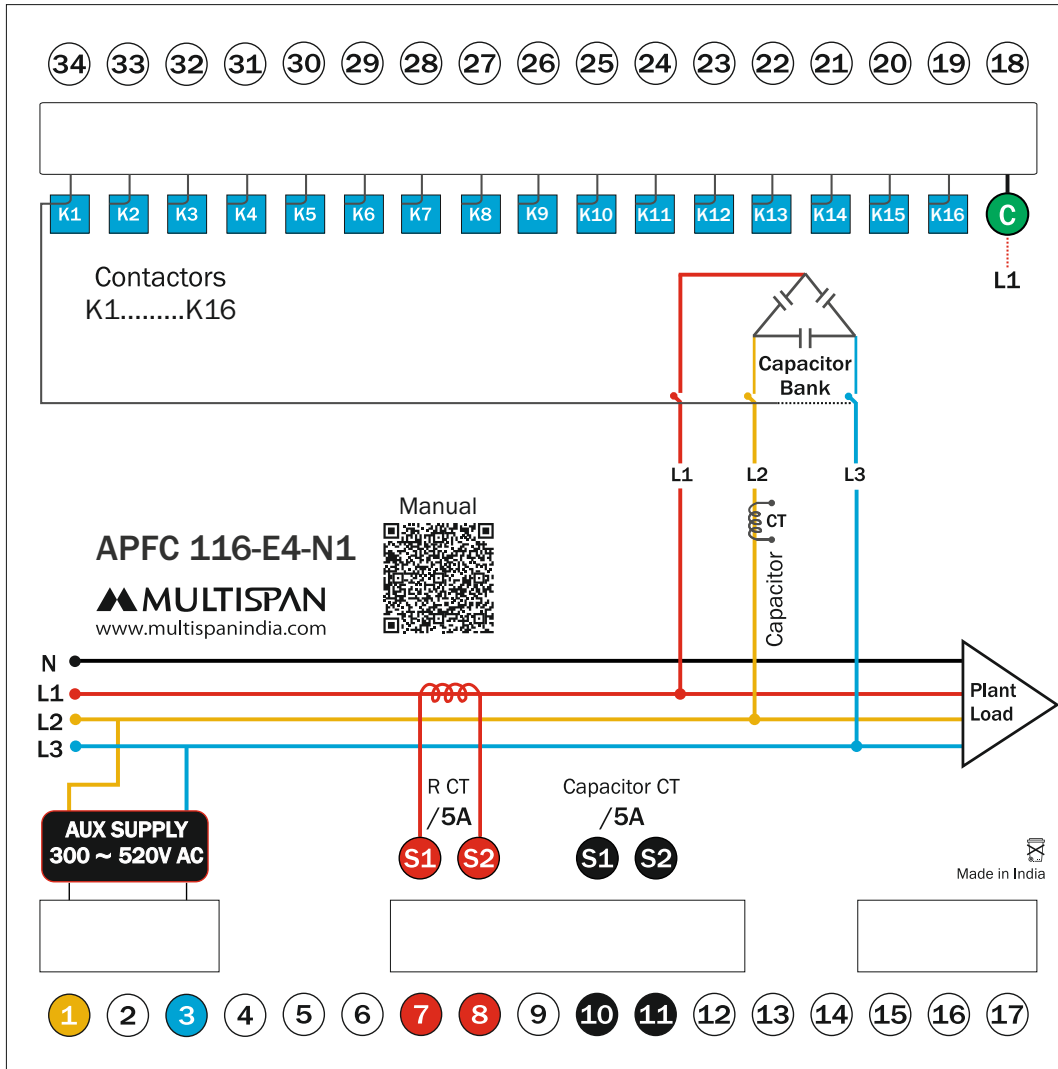

Mechanical Installation

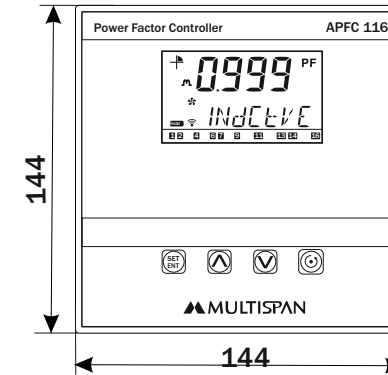

FRONT VIEW

All dimensions are in mm

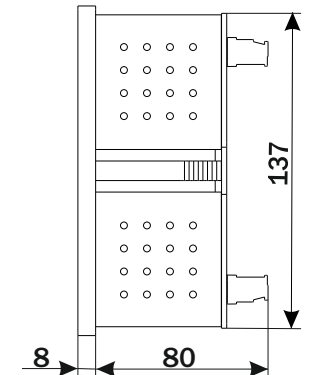

RIGHT SIDE VIEW

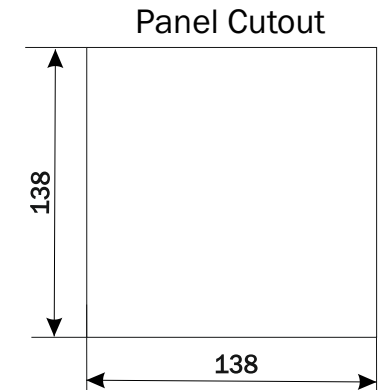

Key Operation

PARAMETER SETTING MODE	
To Set Parameter Value	SET ENT
To Increment parameter value	▲
To Decrement parameter value	▼
To Exit from parameter setting	↻

Display Pages

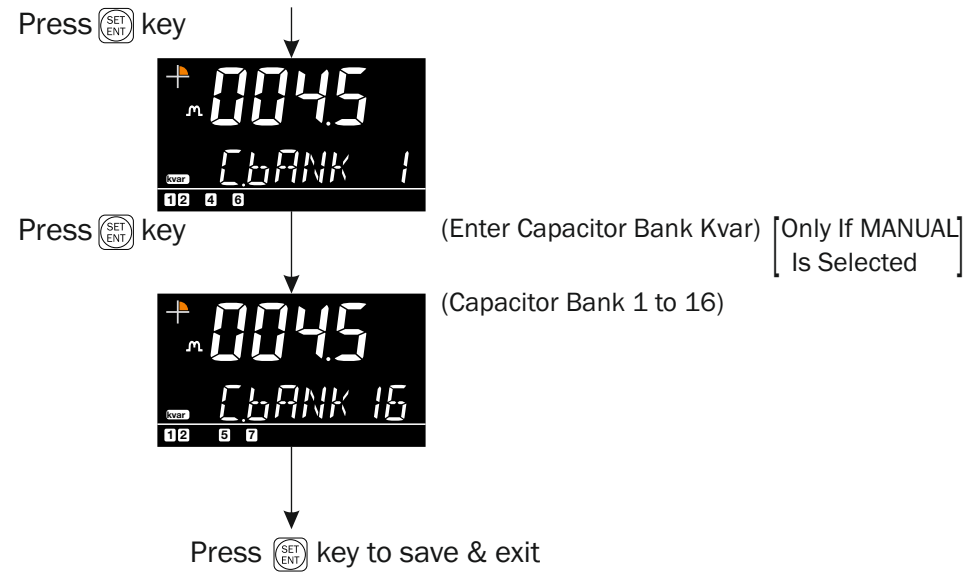
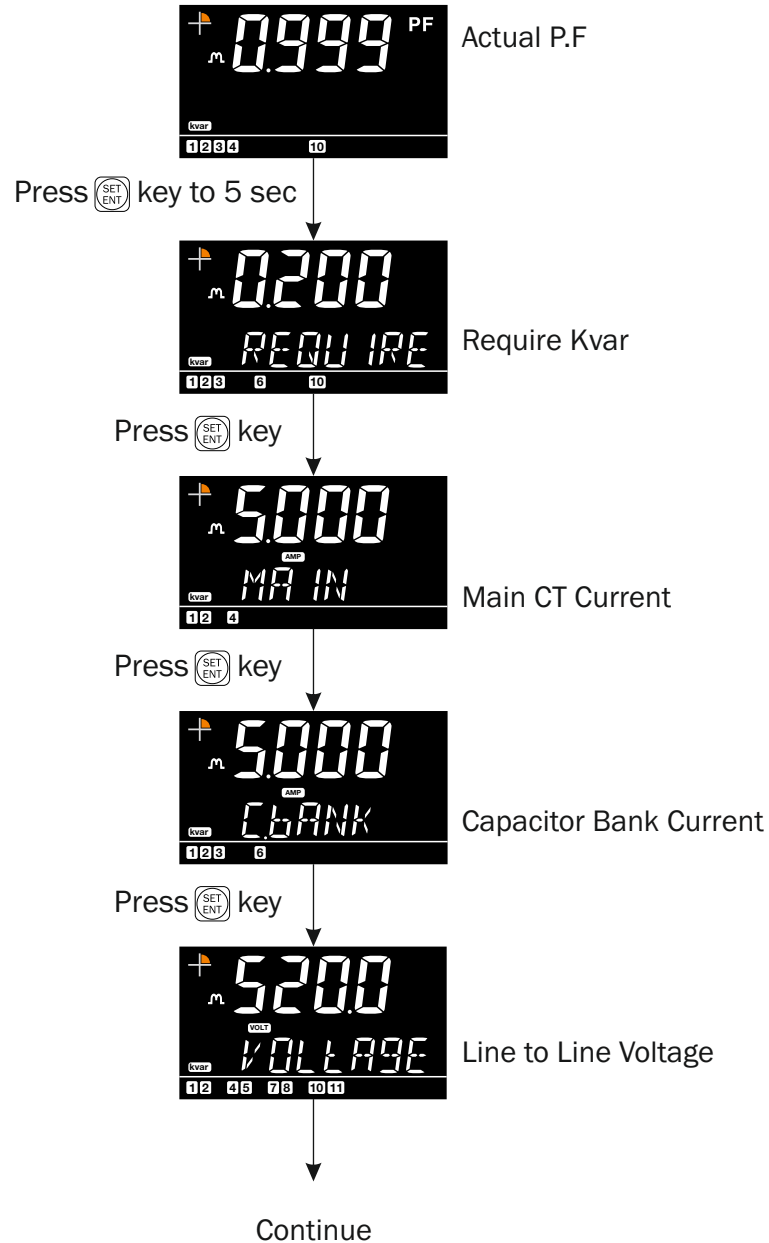

Factory Reset

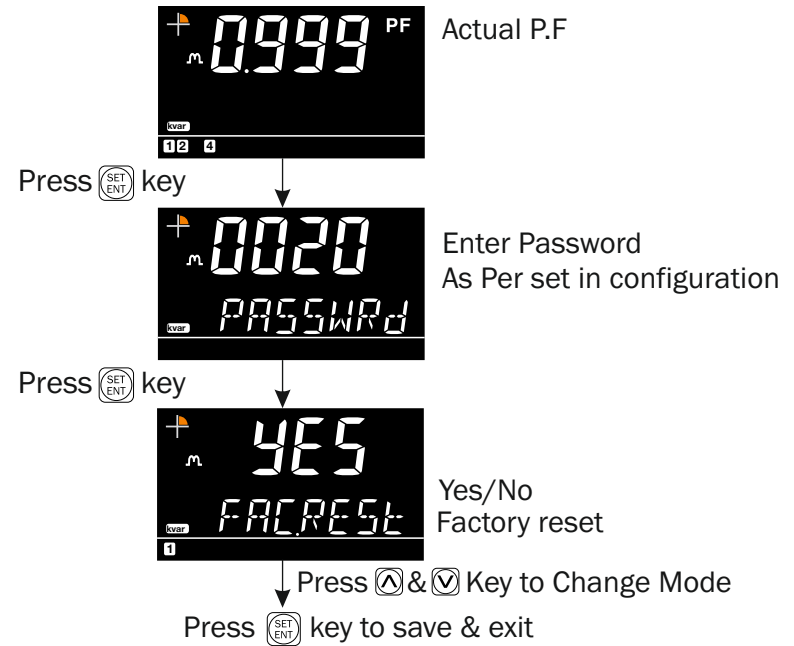

Parameters

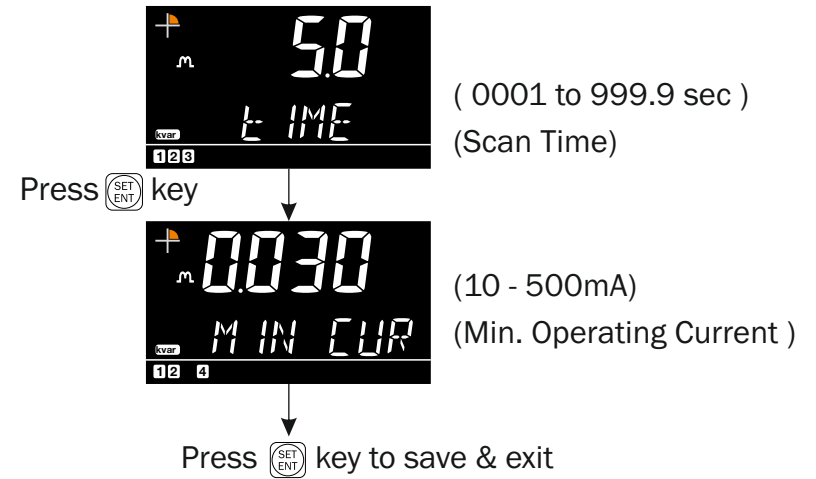
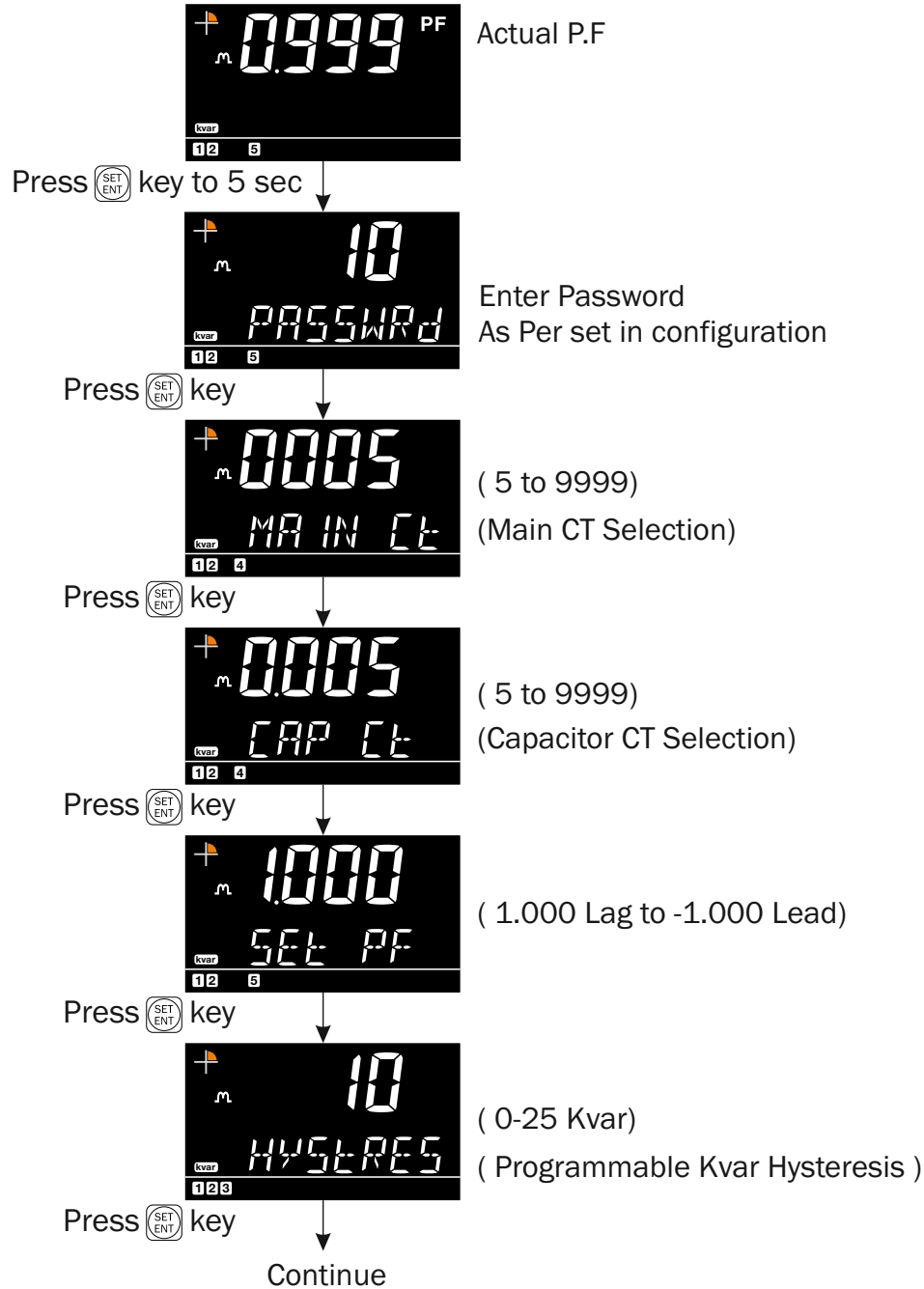

PARAMETERS	FACTORY SET
Hysteresis	0.1 KVAR
Scan Time	5 Sec
Control Mode	Kvar Mode
Capacitor Bank Sensing	Manual

Parameter Range

PARAMETERS	RANGE
Hysteresis	0 to 25 KVAR
Scan Time	1 to 999.9 Sec
Control Mode	Kvar / Intel / Manual
Capacitor Bank Sensing	Manual /Capacitor CT

Controlling Page

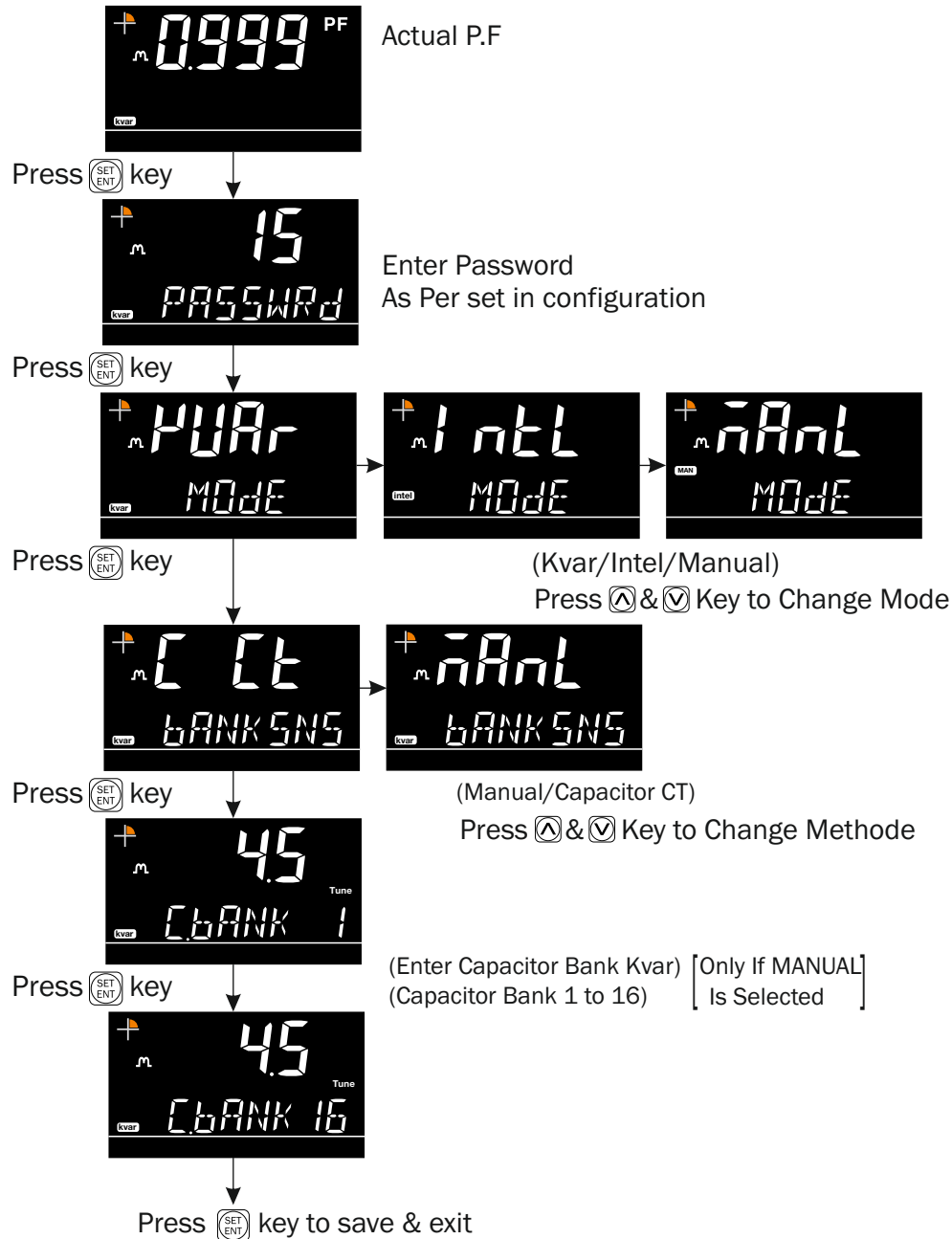

Working

Control Mode:

1) Kvar Mode :

- When this mode is selected, capacitor bank switching step is not fixed and the program automatically select the most appropriate steps to switch capacitor bank "ON" or "OFF" in order to achieve target PF by shortest reaction time with minimum number of steps.

2) Intel Mode :

- When this mode is selected the capacitor steps are controlled by increment of lowest KVAR value of capacitor bank to higher KVAR value of capacitor bank combinations using binary steps to achieve required KVAR value and target PF.

3) MANUAL Mode :

- When this mode is selected the capacitor steps are controlled manually by the UP () and DOWN () KEY.

Capacitor Bank Sensing :

1) MANUAL :

- If customer select manual Capacitor Bank Sensing method then it will be mandatory to enter capacitor bank KVAR value for each step.
- No need for external CT.

2) CAPACITOR CT :

- If customer select Capacitor CT Capacitor Bank Sensing method than capacitor bank automatically sense by capacitor CT.
- The use of capacitor CT is mandatory.

Other Setting :

1) SCAN TIME :

- This parameter set the switching speed of capacitor bank. A larger sensitivity time will result in slower switchingspeed. (Range : 0 to 999.9 sec)
- This sensitivity applies to both switching “ON” and switching “OFF” of the capacitor

2) PROGRAMMABLE Kvar HYSTERESIS :

- The programmable Kvar hysteresis applicable on required KVAR value to achieve target PF. (Range : 0 to 25 KVAR)
- This setting applies to both inductive & capacitive KVAR Requirement

3) Minimum Operating Current :

- If customer select the value of operating current, than in case of secondary CT Current Less then selected value.
- Then APFC Relay will stop controlling (Range : 10 to 500mA)

4) Target PF:

- This set the targeted power factor required when the system is under automatic mode. The power factor regulator will switch the capacitors in or out in order to achieve this set value.

Four Quadrant Representation

- As Per IEC 387 IF Reactive Power is Positive (+Ve) than it is consider as a Inductive Load if Reactive Power is Negative (-Ve) then it is consider as Capacitive load.
- In Quadrant 1 a positive reactive power indicate an inductive power factor.
- In Quadrant 2 a negative reactive power indicate an capacitive power factor.
- In Quadrant 3 a negative reactive power indicate an capacitive power factor.
- In Quadrant 4 a positive reactive power indicate an inductive power factor.

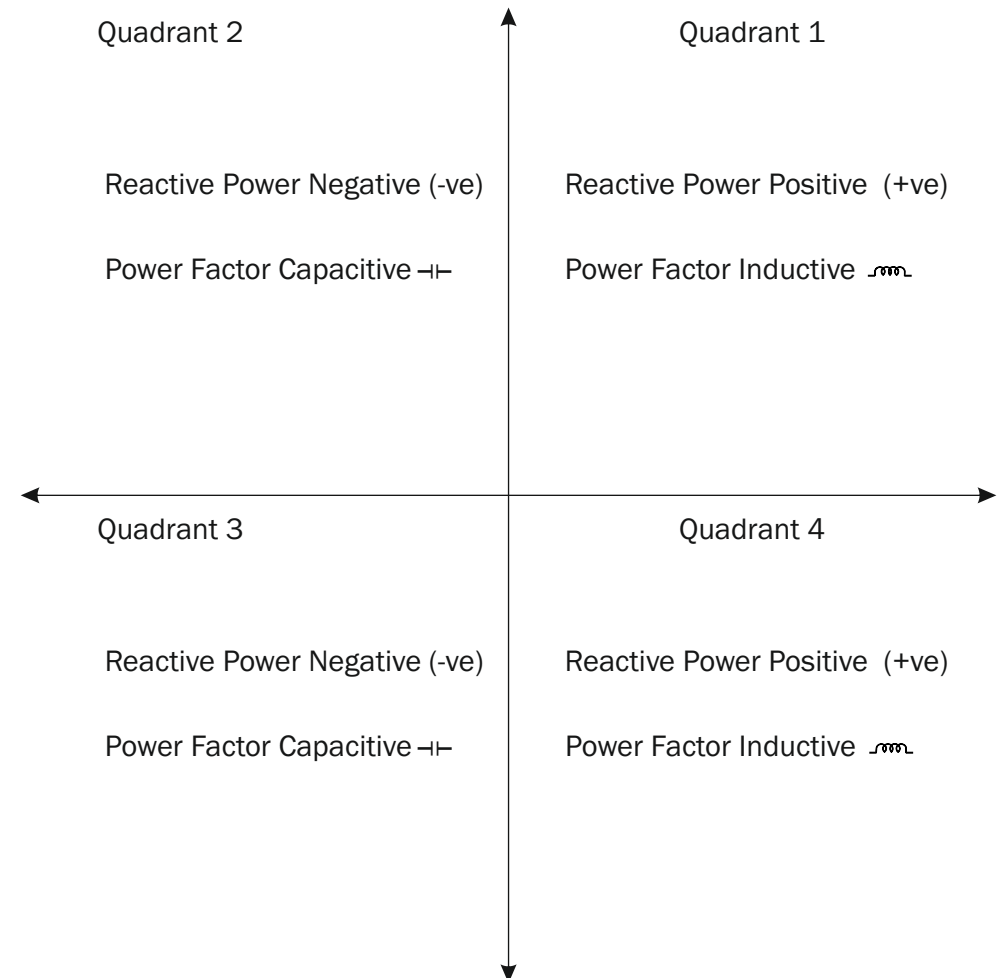

Mechanical Installation Guideline

- 1) Prepare the panel cutout with proper dimensions as shown above.
- 2) Fit the unit into the panel with the help of clamp given.
- 3) The equipment in its installed state must not come in close proximity to any heating source, caustic vapors, oil steam, or other unwanted process byproducts.
- 4) Use the specified size of crimp terminal (M3.5 screws) to wire the terminal block. Tightening the screws on the terminal block using the tightening torque of the range of 1 N.m.
- 5) Do not connect anything to unused terminals.

Safety Precaution

Please read the "Safety Warnings" in the instruction manual supplied with the instrument thoroughly and completely for correct use. Failure to follow the safety rules can cause fire, trouble, electrical shock, etc. Therefore, make sure to operate the instrument on a correct power supply and voltage rating marked on each instrument.

If all the equipment is not handled in a manner specified by the manufacturer, it might impair the protection provided by the equipment.



Read complete instructions prior to installation and operation of the unit.



WARNING : Risk of electric shock.

Warning Guidelines



WARNING : Risk of electric shock.

- 1) To prevent the risk of electric shock, power supply to the equipment must be kept OFF while doing the wiring arrangement. Do not touch the terminals while power is being supplied.
- 2) To reduce electro magnetic interference, use wire with adequate rating and twists of the same of equal size shall be made with shortest connection.
- 3) Cable used for connection to power source, must have a cross section of 1mm or greater. These wires should have insulations capacity made of at least 1.5kV.
- 4) A better anti-noise effect can be expected by using standard power supply cable for the instrument.

Installation Guidelines

- 1) Do not allow pieces of metal, wire clippings, or fine metallic fillings from installation to enter the product or else it may lead to a safety hazard that may in turn endanger life or cause electrical shock to the operator.
- 2) Circuit breaker or mains switch must be installed between power source and supply terminal to facilitate power 'ON' or 'OFF' function. However this mains switch or circuit breaker must be installed at convenient place normally accessible to the operator.
- 3) Use and store the instrument within the specified ambient temperature and humidity ranges as mentioned in this manual.

Maintenance

- 1) The equipment should be cleaned regularly to avoid blockage of ventilating parts.
- 2) Clean the equipment with a clean soft cloth. Do not use isopropyl alcohol or any other cleaning agent.
- 3) Fusible resistor must not be replaced by operator.